

D

C

B

A

4

4

3

3

2

2

1

1

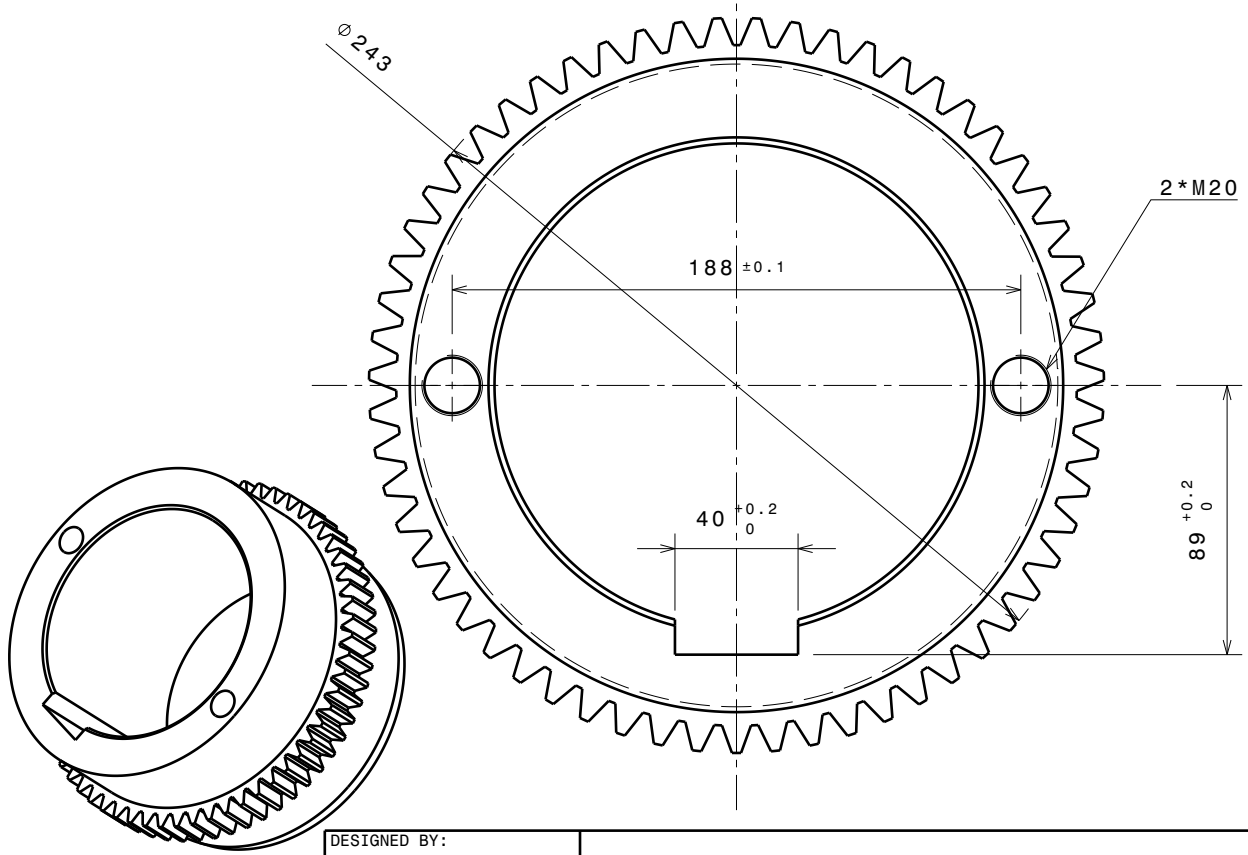
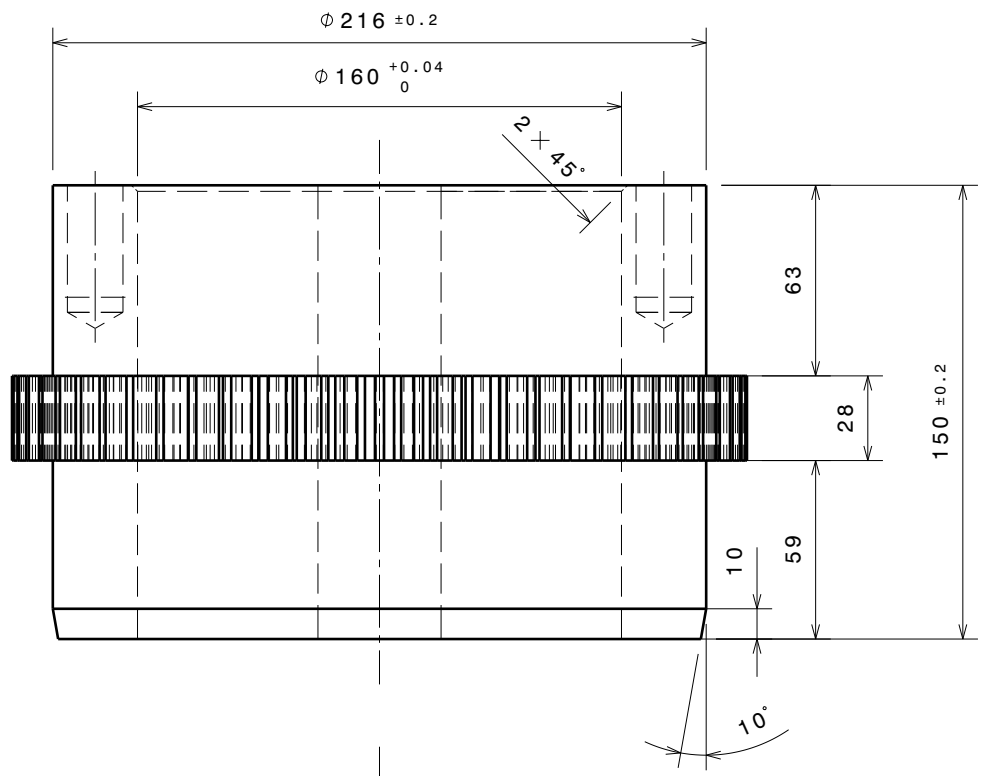

DESIGNED BY: M. NAZARI					
DATE:					
CHECKED BY:					
DATE:					
APPROVED BY:					
DATE:					
SIZE A4		TITLE: XXX	MATERIAL: CK45		
SCALE 2:5	WEIGHT	DRAWING CODE:	SHEET: 1	General Tolerance DIN7168 Group	
REV: 0	This drawing is our property; it can't be reproduced or communicated without our written agreement				

D

A